



# EGOTERIC

AZ-1

Digital Pre Main Amplifier  
Owner's Manual

	<b>CAUTION</b> RISK OF ELECTRIC SHOCK DO NOT OPEN	
CAUTION: TO REDUCE THE RISK OF ELECTRIC SHOCK, DO NOT REMOVE COVER (OR BACK). NO USER-SERVICEABLE PARTS INSIDE. REFER SERVICING TO QUALIFIED SERVICE PERSONNEL.		



The lightning flash with arrowhead symbol, within an equilateral triangle, is intended to alert the user to the presence of uninsulated "dangerous voltage" within the product's enclosure that may be of sufficient magnitude to constitute a risk of electric shock to persons.



The exclamation point within an equilateral triangle is intended to alert the user to the presence of important operating and maintenance (servicing) instructions in the literature accompanying the appliance.

## IMPORTANT SAFETY INSTRUCTIONS

- 1) Read these instructions.
- 2) Keep these instructions.
- 3) Heed all warnings.
- 4) Follow all instructions.
- 5) Do not use this apparatus near water.
- 6) Clean only with dry cloth.
- 7) Do not block any ventilation openings. Install in accordance with the manufacturer's instructions.
- 8) Do not install near any heat sources such as radiators, heat registers, stoves, or other apparatus (including amplifiers) that produce heat.
- 9) Do not defeat the safety purpose of the polarized or grounding-type plug. A polarized plug has two blades with one wider than the other. A grounding type plug has two blades and a third grounding prong. The wide blade or the third prong are provided for your safety. If the provided plug does not fit into your outlet, consult an electrician for replacement of the obsolete outlet.
- 10) Protect the power cord from being walked on or pinched particularly at plugs, convenience receptacles, and the point where they exit from the apparatus.
- 11) Only use attachments/accessories specified by the manufacturer.
- 12) Use only with the cart, stand, tripod, bracket, or table specified by the manufacturer, or sold with the apparatus. When a cart is used, use caution when moving the cart/apparatus combination to avoid injury from tip-over. 
- 13) Unplug this apparatus during lightning storms or when unused for long periods of time.
- 14) Refer all servicing to qualified service personnel. Servicing is required when the apparatus has been damaged in any way, such as power-supply cord or plug is damaged, liquid has been spilled or objects have fallen into the apparatus, the apparatus has been exposed to rain or moisture, does not operate normally, or has been dropped.
  - Do not expose this apparatus to drips or splashes.
  - Do not place any objects filled with liquids, such as vases, on the apparatus.
  - Do not install this apparatus in a confined space such as a book case or similar unit.
  - The apparatus draws nominal non-operating power from the AC outlet with its POWER switch in the off position.
  - The apparatus should be located close enough to the AC outlet so that you can easily grasp the power cord plug at any time.
  - An apparatus with Class I construction shall be connected to an AC outlet with a protective grounding connection.

**WARNING: TO PREVENT FIRE OR SHOCK HAZARD, DO NOT EXPOSE THIS APPLIANCE TO RAIN OR MOISTURE.**

**CAUTION**

- DO NOT REMOVE THE EXTERNAL CASES OR CABINETS TO EXPOSE THE ELECTRONICS. NO USER SERVICEABLE PARTS ARE WITHIN!
- IF YOU ARE EXPERIENCING PROBLEMS WITH THIS PRODUCT, CONTACT TEAC FOR A SERVICE REFERRAL. DO NOT USE THE PRODUCT UNTIL IT HAS BEEN REPAIRED.

**For U.S.A.**

This equipment has been tested and found to comply with the limits for a Class B digital device, pursuant to Part 15 of the FCC Rules. These limits are designed to provide reasonable protection against harmful interference in a residential installation. This equipment generates, uses, and can radiate radio frequency energy and, if not installed and used in accordance with the instructions, may cause harmful interference to radio communications. However, there is no guarantee that interference will not occur in a particular installation. If this equipment does cause harmful interference to radio or television reception, which can be determined by turning the equipment off and on, the user is encouraged to try to correct the interference by one or more of the following measures:

- Reorient or relocate the equipment and/or the receiving antenna.
- Increase the separation between the equipment and receiver.
- Connect the equipment into an outlet on a circuit different from that to which the receiver is connected.
- Consult the dealer or an experienced radio/TV technician for help.

**CAUTION**

Changes or modifications to this equipments not expressly approved by TEAC CORPORATION for compliance will void the user’s warranty.

**CAUTION Regarding Placement**

To maintain proper ventilation, be sure to leave a space around the unit (from the largest outer dimensions including projections) equal to, or greater than, shown below.

Left and Right Panels: 5 cm (2")  
Rear Panel: 10 cm (4")  
Top Panel: 20 cm (8")

**Contents**

**Thank you for choosing Esoteric. Read this manual carefully to get the best performance from this unit.**

Before Use . . . . . 4  
Speaker Connections . . . . . 5  
Connections . . . . . 6  
i.LINK (IEEE 1394) . . . . . 8  
Remote Control Unit. . . . . 9  
Restoring factory settings . . . . . 9  
Front panel features . . . . . 10  
Understanding the remote control unit . . . . . 11

Basic Operation. . . . . 12  
Muting . . . . . 13  
Display dimming . . . . . 13  
Word sync . . . . . 14

Basic Settings . . . . . 14  
Gain Setting for Analog Audio Input . . . . . 16  
Name and skip setting of the INPUT knob . . . . . 17

Troubleshooting . . . . . 18  
Specifications . . . . . 19

### What's in the box

Please confirm that the following accessories are in the box when you open it.

- Remote control unit (RC-1056) x 1
- Batteries (AA, R6, SUM-3) x 2
- Felt sheet x 4
- Power cord x 1
- Owner's manual x 1
- Warranty card x 1

### Read this before operation

- As the unit may become warm during operation, always leave sufficient space around the unit for ventilation. The ventilation holes should not be covered. Make sure there is at least 20 cm (8") of space above and at least 5 cm (2") of space on each side of the unit. Do NOT place anything on top of the unit.
- The voltage supplied to the unit should match the voltage as printed on the rear panel. If you are in any doubt regarding this matter, consult an electrician.
- Choose the installation location of your unit carefully. Avoid placing it in direct sunlight or close to a source of heat. Also avoid locations subject to vibrations and excessive dust, heat, cold or moisture.
- Do not place the unit on the amplifier/receiver.
- Do not open the cabinet as this might result in damage to the circuitry or electrical shock. If a foreign object should get into the unit, contact your dealer or service company.
- When removing the power plug from the wall outlet, always pull directly on the plug, never yank the cord.
- Do not attempt to clean the unit with chemical solvents as this might damage the finish. Use a clean, dry or slightly damp cloth.
- To protect easily scratched furniture, you may stick the felt supplied with the unit to the feet.
- Keep this manual in a safe place for future reference.

### Maintenance

If the surface of the unit gets dirty, wipe with a soft cloth or use diluted neutral cleaning liquid. Be sure to remove any fluid completely. Do not use thinner, benzine (naphtha) or alcohol as they may damage the surface of the unit.

### Short Circuit and Output Protection

"OVER LEVEL" blinks on the display when the short circuit protection (or the output protection) is activated. In this case, turn the unit off and check the speaker cables. The metal portions of the two separate wires should not touch.

If there is no shorted wire, turn down the volume using the VOLUME knob.

### Thermal Overload Protection

"HIGH TEMP" blinks on the display when the overload protection is activated. In this case, turn the unit off and leave it for a few hours to cool it down.

Also check the location of your unit. Place the unit in a cool place, and always leave sufficient space around the unit for ventilation.

"Super Audio CD" is a registered trademark.

"DSD" is a registered trademark.

The i.LINK logo is a trademark of Sony Corporation, registered in the U.S. and other countries.

# Speaker Connections

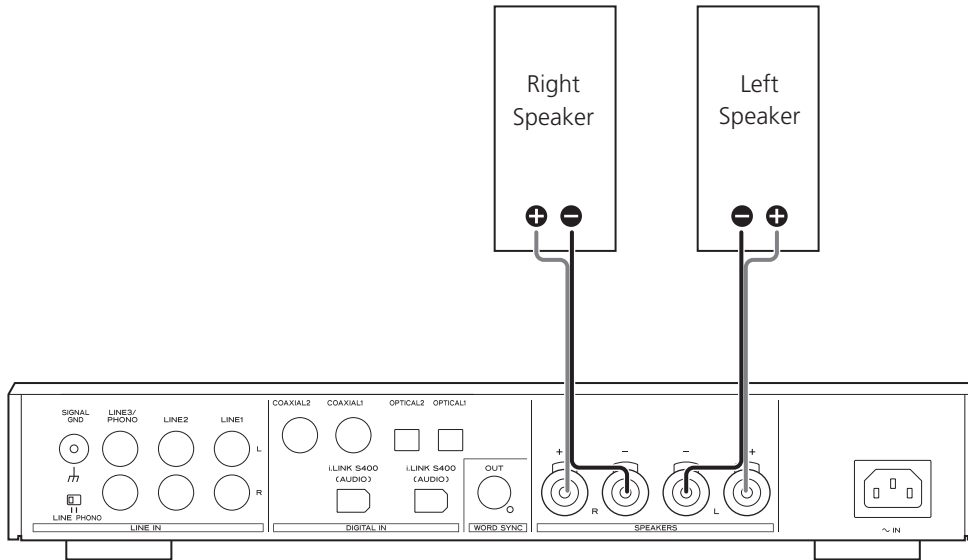

## CAUTION:

- Switch off the power to all equipment before making connections.
- Read the instructions of each component you intend to use with this unit.
- Be sure to insert each plug securely. To prevent hum and noise, avoid bundling the signal interconnection cables together with the AC power cord or speaker cables.

## Note:

- The black speaker terminals are – (negative). Generally, the + side of the speaker cable is marked to make it distinguishable from the – side of the cable. Connect this marked side to the + terminal and the unmarked side to the black – terminal.
- The metal portions of the two separate wires should not touch or an electrical short can occur. Shorted wires can create a fire hazard or induce a failure in your equipment.
- Ideally, left and right speaker cables should be the same length. And the length of cables should be as short as possible for better sound quality.

## Connection using speaker cables with banana plugs

Tighten the terminal cap and insert a banana plug.

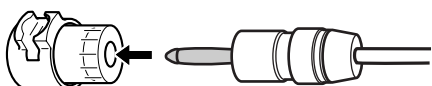

## Connection using speaker cables with spades or bare wire

1. Turn the terminal cap counterclockwise to loosen it. The speaker terminal caps cannot be fully removed from the base.
2. Insert the wire or spade into the terminal and turn the terminal cap clockwise to securely connect it:

Make sure none of the wire insulation is under the terminal, only the bare, stripped wire.

3. Make sure it is fastened firmly by pulling the cable lightly.

- The inside diameter of spades should be 8 mm or more.

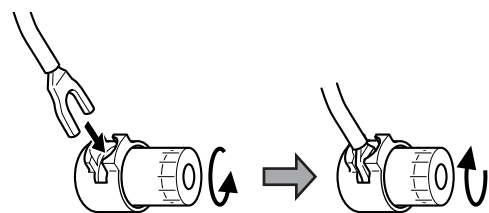

## When your speaker cable has bare wire at the end

Prepare the speaker cables for connection by stripping off approximately 10 mm (1/2") or less of the outer insulation. (Removing too much insulation may lead to a short circuit if the bared wires should come in contact with each other.) Twist the strands of the stripped wires tightly together. The thickness of wires should be less than 4 mm (1/8").

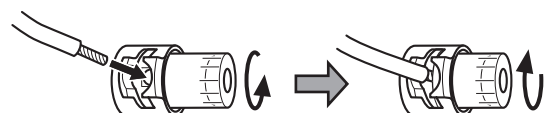

# Connections

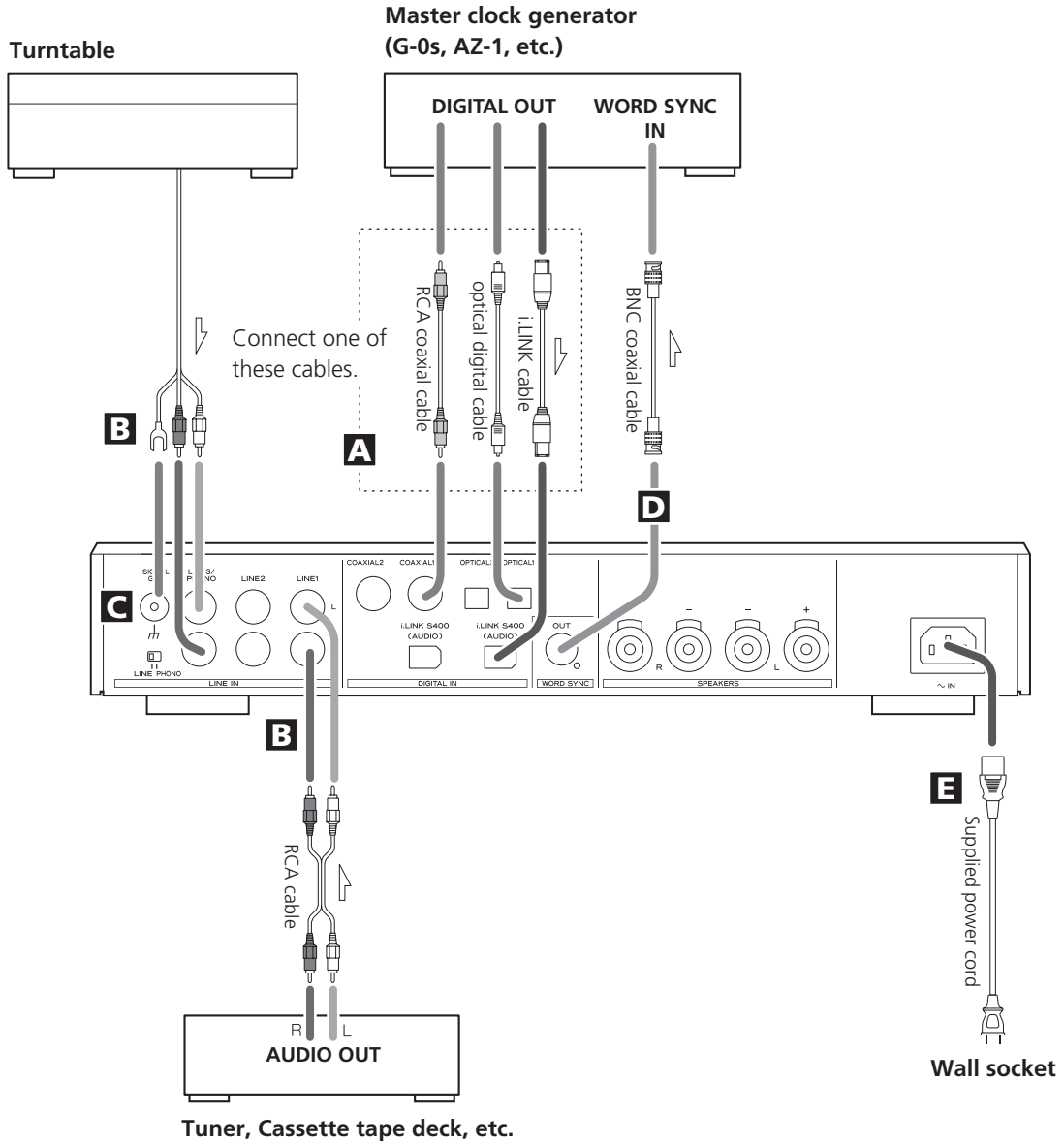

When you are using two or three AZ-1 units for multi-channel listening, connect them as shown here.

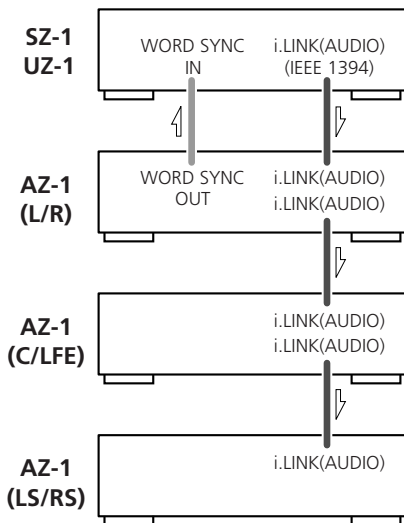

### Setting of the SZ-1/UZ-1

i.LINK button	"PCM"
WORD button	"ON"
Analog Out setting	"Multi ch"
Digital Out setting	"ON"
CD Direct setting	"Normal"
Speaker setting	necessary

### Setting of the AZ-1

INPUT	"i.LINK"
WORD button	One of the AZ-1 that receives channel L/R: "W_OUT" The others: "OFF"
W_OUT setting	"176.4" or "88.2"
CH setting	respective channels
i_RC setting	"ON"

### CAUTION:

- Switch off the power to all equipment before making connections.
- Read the instructions of each component you intend to use with this unit.
- Be sure to insert each plug securely. To prevent hum and noise, avoid bundling the signal interconnection cables together with the AC power cord or speaker cables.

## **A** Digital audio input terminals [DIGITAL IN]

Connect any one of these terminals to the digital output terminal of a digital device (SZ-1, UZ-1, etc.) using a commercially available cable.

COAXIAL (RCA): Use RCA (pin) digital audio cable  
OPTICAL: Use optical digital audio cable (TOS)  
i.LINK (AUDIO): Use S400 compatible IEEE1394 6pin cable

- The i.LINK (AUDIO) terminal is an interface that transmits data both ways between the AZ-1 and an external device. You don't need to be concerned with distinguishing between inputs and outputs.
- The optical terminal is covered by a shutter. Make sure that the cable is firmly inserted, but do not force the cable when connecting it or removing it, in order not to cause damage to the unit.
- The COAXIAL (RCA) and OPTICAL terminals cannot transmit the digital audio from Super Audio CDs.
- If Esoteric SZ-1 or UZ-1 is connected to the AZ-1 using an i.LINK cable, the following setup will provide you with the best quality sound:  
i.LINK button: PCM  
Digital Output setting: ON

## **B** Analog audio input terminals [LINE IN]

Used for the input of analog 2-channel audio signals from a cassette tape deck, tuner, etc.  
Connect the component with commercially-available RCA cables.

Make sure to connect :

- white plug → white jack (L: left channel)
- red plug → red jack (R: right channel)

## **LINE3/PHONO terminal**

In addition to a cassette tape deck or tuner, you can also connect a turntable to this terminal.  
Connect the ground lead of the turntable to the SIGNAL GND terminal of the AZ-1. (But if low frequency noises are heard, it might be better not to connect the ground lead.)

The cartridge of the turntable should be Moving Magnet or similar.

## **LINE3/PHONO switch**

Select PHONO when a turntable is connected to the LINE3/PHONO terminal. Select LINE3 when a cassette tape deck, tuner, etc. is connected to the LINE3/PHONO terminal.

## **C** SIGNAL GND connection

Use a commercially available PVC-covered cord to connect the signal ground terminal on the unit to the player's signal ground.

- Note that this is NOT an electrical safety ground (earth).
- When a turntable is connected, make sure to connect the ground lead of the turntable.

## **D** WORD SYNC output terminal

This sends out a sync signal (word).  
Connect this to the WORD IN terminal of a digital device such as the SZ-1, UZ-1, etc.  
For connection, use a commercially available BNC coaxial digital cable (75Ω impedance).

## **E** Power cord receptacle

After all other connections have been made, insert the supplied AC power cord into this receptacle, then connect the other end of the power cord into the wall socket. Ensure that your AC voltage corresponds to the voltage marked on the rear panel of the unit. Consult a qualified electrician if you are in doubt.

- In order to avoid the risk of electric shock, fire, and so on, only use the supplied power cord.
- If you are not going to use the unit for some time, disconnect the power cord from the wall socket.

i.LINK is also known as IEEE 1394, an international specification. This unit is ready to accept i.LINK (AUDIO).

By connecting an i.LINK (AUDIO)-capable device to the IEEE 1394, or i.LINK (AUDIO) terminal on this unit using an i.LINK cable, you can transmit Super Audio CD multi-channel signals that could not be transmitted except in analog format in the past. Now a Super Audio CD digital signal can be transmitted in its original digital format in addition to transmitting 2-ch linear PCM data and multi-channel compressed audio signals.

If you have multiple i.LINK-capable devices, you can connect them through other devices to transmit data between them, so you don't need to be concerned with the order of connection.

## Copyright protection system DTCP

To play back audio sounds recorded on Super Audio CD or DVD discs using i.LINK, both the player and the D/A converter need to be ready for the copyright protection system DTCP (Digital Transmission Content Protection).

This unit is equipped with DTCP.

## Data transfer rate

There are three transfer rates using i.Link: 100 Mbps (S100), 200 Mbps (S200), and 400 Mbps (S400). This unit is capable of transferring data at the maximum 400Mbps.

For connection to an i.LINK-capable device, use a commercially available S400-compliant 6-pin i.LINK cable.

When connecting multiple i.LINK-capable devices, avoid connecting a device having slow transfer rate between devices having high transfer rate since this reduces the transfer rate of your whole system. Connect devices having high transfer rate towards the source as far up-stream as possible.

## NOTES

### Flow rate control

This unit supports i.LINK flow rate control. Flow rate control means that audio data transferred via i.LINK is first stored in RAM of this unit after which the high-precision clock in the unit is used to retrieve the data from RAM to avoid the transfer jitter normally associated with i.LINK transfer. This unit transfers commands to the playback device to change the data transfer rate and control the playback device when data accumulated in RAM exceeds or goes below a certain amount due to differences in clock frequencies in the playback device and this unit. Flow rate control functions in transfers between this unit and another unit.

- Among the i.LINK formats there are "MPEG-2 TS" for BS digital source and "DV" for digital video for DVD recorders, as well as the "i.LINK (AUDIO)" (A&M Protocol). Never connect devices that are not ready for i.LINK (AUDIO) to this unit. If you do, this unit and others may get erroneous data or be damaged.
- Avoid plugging or unplugging the i.LINK cables while the player is in use. Preferably, make all connections when the power is off.
- Among the i.LINK-capable devices there are some that, if not turned on, are not capable of relaying data.
- There is a possibility some i.LINK-capable devices will not respond to this unit's command.

## How to connect multiple i.LINK-capable devices

### Daisy-chain connection

You can daisy-chain up to 17 devices including this unit.

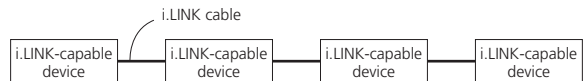

### Connection in tree structure

If you are using a device having three or more i.LINK connectors, you may want to get the connection branched out. This way of connection allows you to connect up to 17 devices including this unit.

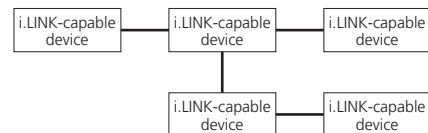

Your system will not work if data is fed back to the original output device. **Be careful not to create a loop.**

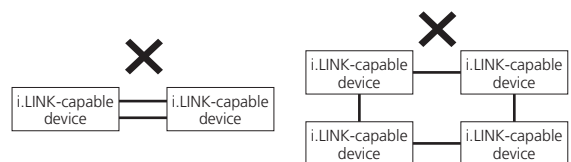

The i.LINK interface of this unit is designed in accordance with the following specifications:

- 1) IEEE Std 1394a-2000, Standard for a High Performance Serial Bus
- 2) Audio and Music Data Transmission Protocol 2.0

This unit is compliant with IEC 60958 bitstream, DVD-Audio, Super Audio CD in the AM824 sequence adaptation layers of this protocol.

## Remote Control Unit

### How to insert the batteries

Remove the cover of the remote control unit with a screwdriver. After checking the polarity ( $\oplus/\ominus$ ) of two AA batteries, insert the batteries, replace the cover and replace the screws.

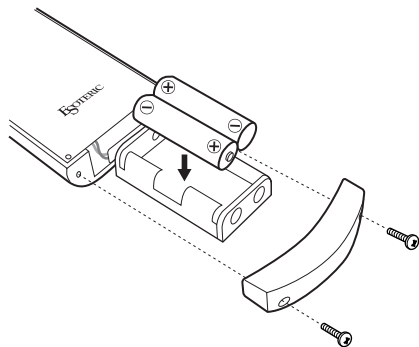

### Battery Replacement

If the distance you can operate your remote decreases, the batteries are exhausted. In this case replace the batteries with new ones.

### Precautions concerning batteries

- Be sure to insert the batteries with correct positive " $\oplus$ " and negative " $\ominus$ " polarities.
- Use batteries of the same type. Never use different types of batteries together.
- Rechargeable or non-rechargeable batteries can be used but not mixed together. Refer to the precautions on their labels.
- When the remote control unit is not to be used for a long time (more than a month), remove the batteries from the remote control unit to prevent them from leaking. If they leak, wipe away the liquid inside the battery compartment and replace the batteries with new ones.
- Do not heat or disassemble batteries and never dispose of old batteries by throwing them in a fire.

### Notes on use

- Point the remote control unit at the main unit's remote sensor within seven meters (23 feet) of the main unit. There should not be any obstacles between the main unit and the remote control unit.
- Do not allow direct sun or other light to shine on the remote sensor part of the main unit. This may cause the remote control unit to work incorrectly.
- Note that other units with remote controls may operate incorrectly because of infrared light "overspill" when you operate this remote control unit.

## Restoring factory settings

If you have made a lot of changes to the setup, and want to restart from a known set of options, restore the unit to the factory settings as follows:

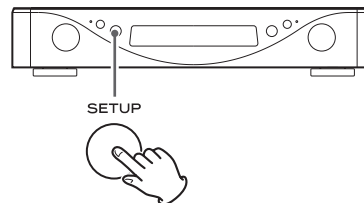

1. Unplug the power cord from the outlet.
2. While holding down the SETUP button, plug the power cord into the outlet.

All memories are erased, and the unit returns to the factory settings.

## Front panel features

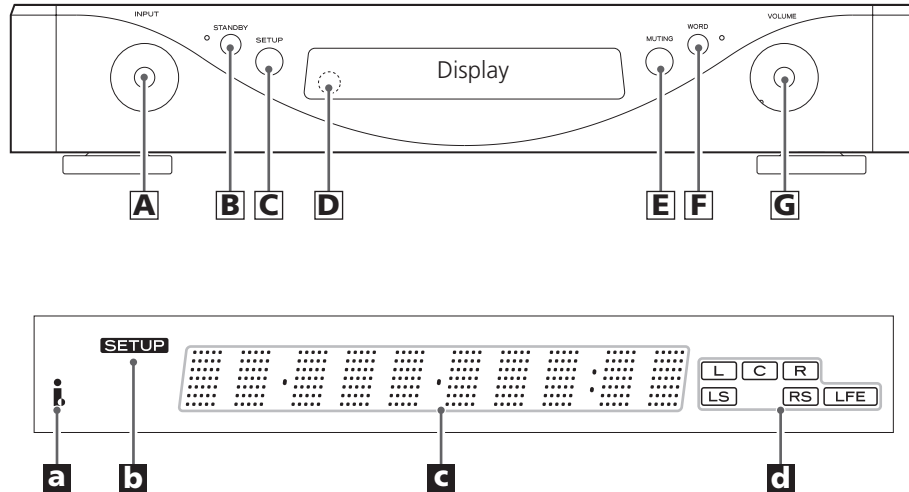

### Front Panel

#### **A** INPUT

Turn this knob to select an input.  
In the setup mode, use this knob to change settings.

#### **B** STANDBY

Use this button to turn the unit on and to standby.  
The indicator is red in the standby mode. It turns blue when the unit is turned on.

The equipment draws nominal non-operating power from the AC outlet with its STANDBY switch in the standby position.

#### **C** SETUP

Press this button to enter or exit the basic setup mode.  
Press and hold this button for more than 2 seconds to enter or exit "Gain Setting for Analog Audio Input" or "Name and skip setting of the INPUT knob" mode.

#### **D** Remote control sensor

Receives signals from the remote control unit. Point the remote control unit at this sensor when operating the remote control unit.

#### **E** MUTING

Use this button to mute the sound.

#### **F** WORD

Use this to turn on or off the word sync function.  
The indicator lights when the word sync is on.

#### **G** VOLUME

Turn this knob to adjust the volume.

### Display

#### **a** i.LINK indicator

Lights when the INPUT knob is set to "i.LINK" or when i\_RC setting is set to ON.

This indicator blinks when the unit cannot perceive the digital signal. In that case, connect a digital device to the i.LINK (AUDIO) terminal and switch it on.

#### **b** SETUP indicator

Lights while in the setup mode.

#### **c** Message area

Alphanumeric display to show sources, sampling frequencies, status messages, etc.

Normally, "current input" is shown on the left of the display. When detecting a device that is connected with i.LINK cable, the display shows its model name (such as SZ-1). The right of the display shows "the sampling frequency of an incoming digital signal" when a CD is played back or "DSD" when a Super Audio CD is played back.

#### **d** Channel indicators

Channels selected during "CH" setup light.

# Understanding the remote control unit

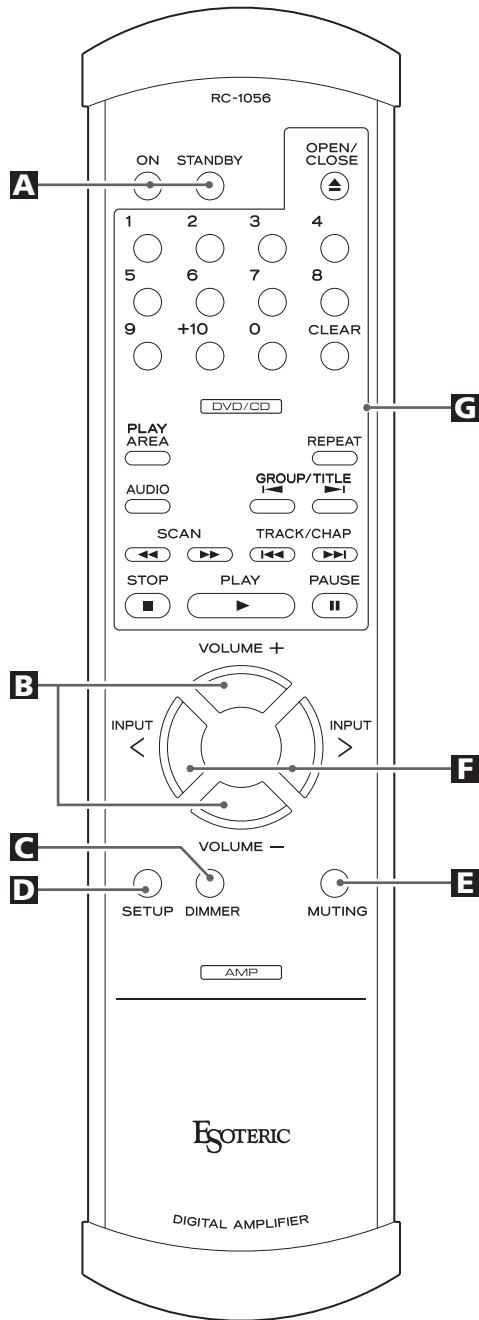

## Note:

To simplify explanations, instructions in this manual refer to the names of the buttons and controls on the front panel only. Associated controls on the remote control will also operate similarly.

### A ON/STANDBY

Use the ON button to turn the unit on.  
Use the STANDBY button to turn it standby.

### B VOLUME

Use these buttons to adjust the volume.

### C DIMMER

Use this button to change the brightness of the front panel display.

### D SETUP

Use this button to enter or exit the setup mode.

### E MUTING

Use this button to mute the sound.

### F INPUT

Use these buttons to select an input.

### G Buttons for the basic operation of Esoteric SZ-1 or UZ-1

You can use these buttons to operate Esoteric SZ-1 or UZ-1. Point the remote control unit at the remote sensor of the SZ-1 or UZ-1.

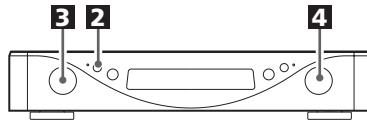

**1** First of all, turn on the power of the connected components.

**2** Press the **STANDBY** button to turn the unit on.

The indicator is red in the standby mode. It turns blue when the unit is turned on.

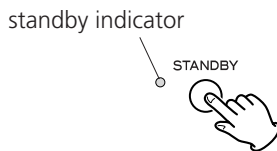

It may take several seconds for the unit to start outputting sounds. Wait until "WAIT ..." disappears from the display.

**3** Select an input by turning the **INPUT** knob.

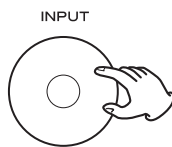

The current input appears on the left of the display. Repeatedly turn the knob until the desired input appears on the display.

COAX1, COAX2, OPT1, OPT2, LINE1, LINE2, LINE3 or PHONO\*, i.LINK

\*: PHONO appears only when the LINE/PHONO switch is set to PHONO.

- When you select a digital terminal, "the sampling frequency of an incoming digital signal" or "DSD" appears on the right of the display.
- i.LINK indicator blinks when the unit cannot recognize the digital signal. In that case, connect a digital device to the i.LINK(AUDIO) terminal and switch it on.

**4** Play the source, and gradually turn up the volume to the required level by turning the **VOLUME** knob.

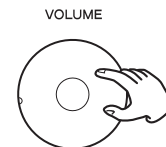

**To turn the unit off (standby)**

To prevent sudden noise from the speakers, make sure to turn the unit off in the following way.

1. Stop the playback of the connected component.
2. Turn the AZ-1 standby using the **STANDBY** button.

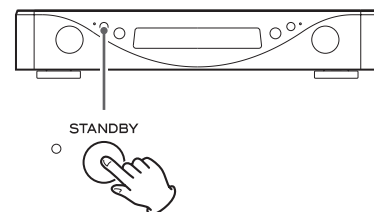

3. Turn the connected components off.

## Muting

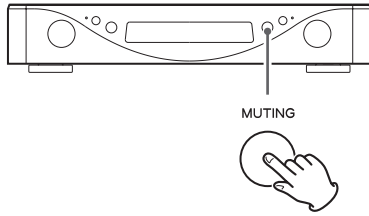

To mute the sound temporarily, press the MUTING button. Press the MUTING button again to restore the sound.

- While muting is engaged, "MUTING" and the name of the selected terminal alternately blink on the display.

## Display dimming

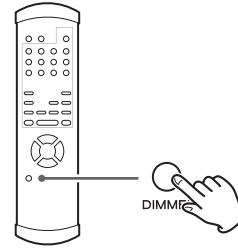

The display on the main unit can be dimmed to suit the environment in which you listen to music. There are three levels and an "off" setting.

**Use the DIMMER button to cycle between these settings.**

- Note that the OFF setting is not memorized when the power is turned off. When the unit is switched off with the display off, and then turned on again, the display is reset to the minimum brightness.
- In OFF mode, when you press a button such as VOLUME, the illuminations turn temporarily on.

## Word sync

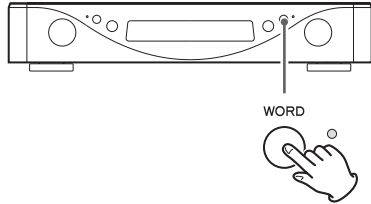

This feature is used when you want to get your whole system locked to a single sync signal (clock) by connecting this unit to the Esoteric SZ-1/UZ-1 or other devices that are capable of inputting a sync signal (word clock).

Use the **WORD** button to switch between **W\_OUT** and **WORD OFF**.

### W\_OUT

The unit internally generates and sends out Word Clock. The indicator lights.

You can change the frequency of the word sync signal. See pages 14 and 15 for details.

- Make WORD SYNC connections before powering on the unit.
- It takes several seconds to detect and lock to a clock. If the received digital signal doesn't match the sync signal, the display shows "WRD ERROR!".

### WORD OFF

The unit does not output a word clock.

## Basic Settings

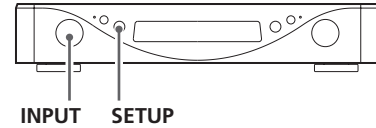

- 1** Repeatedly press the **SETUP** button to select the menu item to be changed.



- If you leave the unit idle for 10 seconds, the setup mode will be cancelled.

- 2** Turn the **INPUT** knob to select the options within the menu item.

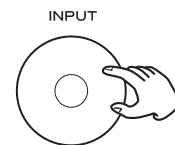

- Repeat steps **1** and **2** as required.

- 3** Repeatedly press the **SETUP** button (or leave the unit idle for 10 seconds) to exit the setup mode.



- Settings are stored even when power is turned off and the unit is unplugged. If left unplugged for an extended period, the settings may be lost.

## W\_OUT (Word sync output frequency)

Select the frequency of the word sync signal. The factory setting is "44.1".

100 ↔ 44.1 ↔ 88.2 ↔ 176(176.4) ↔ 48 ↔ 96 ↔ 192

- The word sync signal is output only when the WORD button is set to "W\_OUT" (see page 14).

## CH (Channel)

When the i.LINK (AUDIO) terminal is connected to a digital device, select the channels for this unit.

The factory setting is L/R.

L/R: front left and right channels

C/LFE: center channel and LFE (subwoofer)

LS/RS: surround left and right channels

- The icons of the selected channels light on the display.



## i\_RC (i.LINK remote control function)

When multiple AZ-1 units are directly connected using i.LINK cables and you use this function, the volume, muting and dimmer of all AZ-1's in the chain can be controlled using only one AZ-1.

Since this function is available as long as AZ-1's are connected using i.LINK cables, you can use a different input type other than i.LINK.

### ON

The volume, muting and dimmer of all AZ-1's in the chain can be controlled using the L/R channel AZ-1.

### MASTR

### SLAVE

When you set one AZ-1 as master and all other AZ-1's as slaves, the volume, muting and dimmer of all AZ-1's in the chain can be controlled using only the master unit.

This master-slave control has nothing to do with the channel setting.

### OFF (default setting)

Select this setting position when the i.LINK remote control is not used. The volume, muting and dimmer of all AZ-1's in the chain cannot be controlled as a whole.

The i.LINK circuit is powered only when the input is set to i.LINK.

## (Normal display)

Select this to exit the setup mode.

### Note

When two AZ-1's are connected using i.LINK cables and one AZ-1 is connected to the front left speaker and the other AZ-1 is connected to the front right speaker as shown below, one AZ-1 can be used as an amplifier dedicated to the left channel and the other as an amplifier dedicated to the right channel.

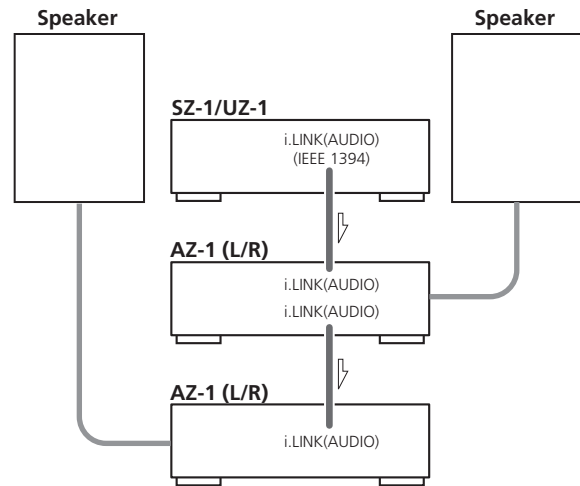

The MASTR and SLAVE settings of the i.LINK remote control function allow you to set one AZ-1 as master and the other as slave, so that the volume, muting and dimmer of the pair units can be controlled in unison using one of the pair units.

# Gain Setting for Analog Audio Input

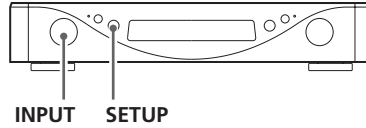

You can adjust the relative volume between the LINE IN terminals. Once the relative volume is set, each component connected to the AZ-1 will have the approximate same volume level.

**1 Select an input to be changed (LINE1, LINE2 or LINE3/PHONO) by turning the INPUT knob.**

Start with the component that has the lowest volume level.

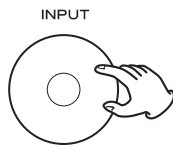

**2 Press and hold the SETUP button for more than 2 seconds.**



The unit enters setup mode, and "GainL\*>\*\*\*" appears on the display. (\*\*\*) changes depending on your setting.)

If you leave the unit idle for 10 seconds, the setup mode will be cancelled.

**3 Turn the INPUT knob to change the Gain setting.**

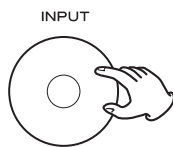

Adjustable range: 0, +3, +6, +9, +12, +15, +18, +21, +24

**4 Press and hold the SETUP button for more than 2 seconds (or leave the unit idle for 10 seconds) to exit the Gain setup mode.**



- Settings are stored even when power is turned off and the unit is unplugged. If left unplugged for an extended period, the settings may be lost.
- If you lightly press the SETUP button, the unit enters name and skip setting mode. See page 17 for details.

## Name and skip setting of the INPUT knob

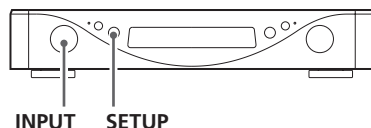

The names of the inputs shown on the display can be changed. You can also set the INPUT knob to skip the input terminals that are not in use.

For example, if a CD player is connected to the COAX1 terminal and a DVD player to the OPT1 terminal, you can change the name of COAX1

### Example:

When a CD player is connected to the COAX1 terminal and a DVD player to the OPT1 terminal

Select "CD" for COAX1  
Select "DVD" for OPT1  
Select "\*skip" for other terminals.

Then only "CD" or "DVD" will appear on the display when you turn the INPUT knob.

### 1 Press and hold the SETUP button for more than 2 seconds.



The unit enters setup mode, and "L-1>\*\*\*" appears on the display. (\*\*\*) changes depending on your setting.)

If the INPUT knob is set to LINE1, LINE2 or LINE3/PHONO, "GainL\*>\*\*\*" will appear instead of "L-1>\*\*\*". In this case, lightly press the SETUP button again to show "L-1>\*\*\*".

If you leave the unit idle for 10 seconds, the setup mode will be cancelled.

### 2 Repeatedly press the SETUP button to select the input terminal to be changed.



L-1(LINE1) → L-2(LINE2) → L-3(LINE3)  
→ i-L(i.LINK) → C-1(COAX1) → C-2(COAX2)  
→ O-1(OPT1) → O-2(OPT2) → (normal display)  
→ L-1(LINE1) → ...

### 3 Turn the INPUT knob to change the setting.

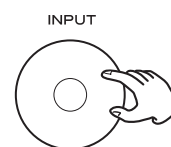

Default name, CD, SACD, DVD, TUNER, MD, CD-R, TAPE, PHONO, MP3, TV, SAT, CATV, DVD-R, VCR, \*skip

- The default name of the LINE3 terminal depends on the LINE3/PHONO switch. When the LINE/PHONO switch is set to LINE, the default name is "LINE3". When the LINE/PHONO switch is set to PHONO, the default name is "PHONO".
- The name of the i.LINK terminal cannot be changed, as the display always shows model name of the connected device. Only "\*skip" is selectable for i.LINK.
- Skip function will not work at all if you set all the input terminals to "\*skip".

### 4 Press and hold the SETUP button for more than 2 seconds (or leave the unit idle for 10 seconds) to exit the setup mode.



- Settings are stored even when power is turned off and the unit is unplugged. If left unplugged for an extended period, the settings may be lost.

In case you experience any problem with this unit, please take the time to look through this chart and see if you can solve the problem yourself before you call your dealer.

## No power

- ➔ Check the connection to the AC power supply. Check and make sure the AC source is not a switched outlet and that, if it is, the switch is turned on. Make sure there is power to the AC outlet by plugging another item such as a lamp or fan.
- ➔ Press the POWER switch of the main unit to turn it on.

## Remote control doesn't work.

- ➔ Press the POWER switch of the main unit to turn it on.
- ➔ If the batteries are dead, change the batteries.
- ➔ Use remote control unit within the range (5m /15ft) and point at the front panel.
- ➔ Clear obstacles between the remote control unit and the main unit.
- ➔ If a strong light is near the unit, turn it off.

## There is no sound or only a very low-level sound is heard.

- ➔ Adjust the volume by turning the VOLUME knob.
- ➔ Select the proper source using the INPUT knob.
- ➔ Check that the speakers and components are connected securely.
- ➔ Check the operation of the connected component.

## No i.LINK output.

- ➔ Check the channel setting. One AZ-1 unit must be set to L/R channel when multiple AZ-1 units are connected.

## No sound from a Super Audio CD.

- ➔ Digital audio from a Super Audio CD cannot go through the OPTICAL or COAXIAL terminals. Use the i.LINK (AUDIO) terminal.

## No digital audio output.

- ➔ The AZ-1 isn't equipped with Dolby Digital/DTS/MPEG decoders. The digital output setting of the connected player must be PCM. Or use analog audio terminals.

## Unstable sound.

- ➔ Speaker polarity (⊕/⊖) is reversed. Check all speakers for correct polarity.

## The i.LINK indicator blinks.

- ➔ Turn on the digital device connected to the i.LINK(AUDIO) terminal. When you don't use the i.LINK terminal, turn the i\_RC setting off.

## The display shows "WRD ERROR!"

- ➔ The connected unit may not be in word sync mode while the AZ-1 is in word sync mode. Check the word sync terminal for correct connection and the settings on the connected unit.
- ➔ The received digital signal doesn't match the sync signal. The proper word sync frequencies for Super Audio CDs are 44.1, 88.2 or 176.4.

## Buzzing noise produced at regular intervals.

- ➔ The connected unit may not be in word sync mode while the AZ-1 is in word sync mode. Check the word sync terminal for correct connection and the settings on the connected unit. Normally, if this problem occurs, the display reads "WRD ERROR!", but this message does not appear when deviation in sync is too small and out of the word error detection threshold of the AZ-1.

**If normal operation cannot be obtained, unplug the power cord from the outlet and plug it again. This resets the internal micro-computer which can be disturbed during electrical storms, power interruptions, et cetera.**

## For European customers Disposal of your old appliance



1. When this crossed-out wheeled bin symbol is attached to a product it means the product is covered by the European Directive 2002/96/EC.
2. All electrical and electronic products should be disposed of separately from the municipal waste stream via designated collection facilities appointed by the government or the local authorities.
3. The correct disposal of your old appliance will help prevent potential negative consequences for the environment and human health.
4. For more detailed information about disposal of your old appliance, please contact your city office, waste disposal service or the shop where you purchased the product.

# Specifications

## General

Power supply	
Europe model . . . . .	AC 230 V, 50 Hz
U.S.A./Canada model . . . . .	AC 120 V, 60 Hz
Korea model . . . . .	AC 220 V, 60 Hz
Power consumption . . . . .	45 W
Weight . . . . .	9.2 kg (20 1/4 lbs)
External dimensions (W x H x D) . . . . .	400 x 77 x 372 mm (15 3/4" x 3 1/16" x 14 5/8")
Operating temperature . . . . .	+5°C - +35°C
Operating humidity . . . . .	5% to 85% (no condensation)
Storage temperature . . . . .	-20°C - +55°C

## Digital Input Terminals

Input format . . . . .	DSD, linear PCM (44.1kHz-192kHz, 16-24bit)
i.LINK (AUDIO) terminal (6pin) x2	
RCA x2, Input level: more than 0.2Vp-p/75Ω	
OPTICAL x2, Input level: -24.0 to -14.5dBm peak	

## Amplifier Section

Output Power . . . . .	45 W + 45 W (1 kHz, 8 ohms)
	75 W + 75 W (1 kHz, 4 ohms)
Minimum impedance . . . . .	4 ohms
Total Harmonic Distortion . . . . .	0.04 % (at 47 W, 1 kHz, 8 ohms)
Frequency Response (COAXIAL, OPTICAL, i.LINK) . . . . .	5 Hz to 95 kHz, -3 dB (at 1 W, 8 ohms)
Signal-to-Noise Ratio (COAXIAL, OPTICAL, i.LINK) . . . . .	more than 115 dB (JEITA)
Input Sensitivity (maximum output at maximum volume) . . . . .	LINE: 150 mVrms
	LINE3 PHONO (MM): 3.2 mVrms
Input impedance . . . . .	LINE: 100 kΩ, PHONO (MM): 39 kΩ
RIAA deviation . . . . .	PHONO (MM): ±0.5 dB (20 Hz-15 kHz)

## Word Clock

Jack . . . . .	BNC
Output level . . . . .	TTL level/75Ω
Word Clock Output Frequency . . . . .	44.1, 88.2, 176.4, 48, 96, 192, 100 (kHz)

## Accessories

Remote control unit (RC-1056) x 1
Batteries (AA, R6, SUM-3) x 2
Felt sheet x 4
Power cord x 1
Owner's manual x 1
Warranty card x 1

- Design and specifications are subject to change without notice.
- Weight and dimensions are approximate.
- Illustrations may differ slightly from production models.

# ESOTERIC

---

<b>TEAC ESOTERIC COMPANY</b>	3-7-3, Nakacho, Musashino-shi, Tokyo 180-8550, Japan Phone: (0422) 52-5132 e-mail: eso-os@tec.teac.co.jp
TEAC AMERICA, INC.	7733 Telegraph Road, Montebello, California 90640 Phone: (323) 726-0303
TEAC CANADA LTD.	5939 Wallace Street, Mississauga, Ontario L4Z 1Z8, Canada Phone: (905) 890-8008
TEAC MEXICO, S.A. De C.V	Campesinos N°184, Colonia Granjas Esmeralda, Delegacion Iztapalapa, CP 09810, México DF Phone: (525) 581-5500
TEAC UK LIMITED	Unit 19 & 20, The Courtyards, Hatters Lane, Watford, Hertfordshire, WD18 8TE, U.K. Phone: (0845) 130-2511
TEAC EUROPE GmbH	Bahnstrasse 12, 65205 Wiesbaden-Erbenheim, Germany Phone: 0611-71580

---

This appliance has a serial number located on the rear panel. Please record the model number and serial number and retain them for your records.

Model number \_\_\_\_\_ Serial number \_\_\_\_\_

0706·MA-1033B